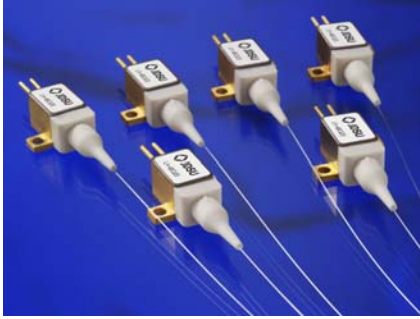

High-Power 2 W 830 nm Fiber-Coupled Diode Laser 2486-L4 Series

**Key Features**

- 2 W output power
- High reliability
- 60 μm aperture
- 0.22 NA
- Isolated electrical contacts

Applications

- Computer-to-plate printing
- Flexographic printing
- Illumination

The new high-brightness 2486-L4 series laser diodes offer up to 2 W from a 60- μm fiber into 0.22 numerical aperture (NA)—ideal for thermal printing and other applications that require high brightness and a long life. The dramatic increase in output power, from the 60-micron fiber, also enables new technologies, such as flexography, illumination, and several material processing applications.

The 2486-L4 series is available with customer-selectable fiber length and fiber termination, including bare fiber, SMA, and ST connectors.

2

Dimensions Diagram

(Specifications in mm unless otherwise noted.)

Standard Tolerances
 mm: x.x = ±0.5
 x.xx = ±0.25

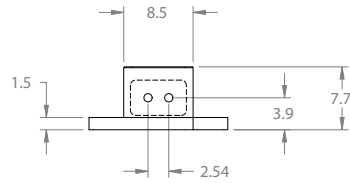
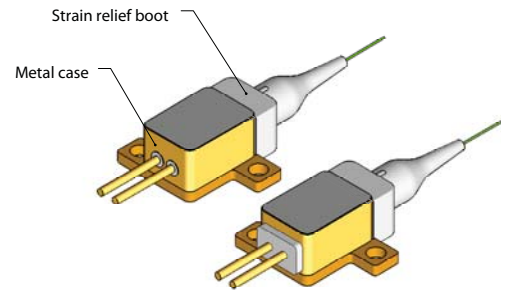
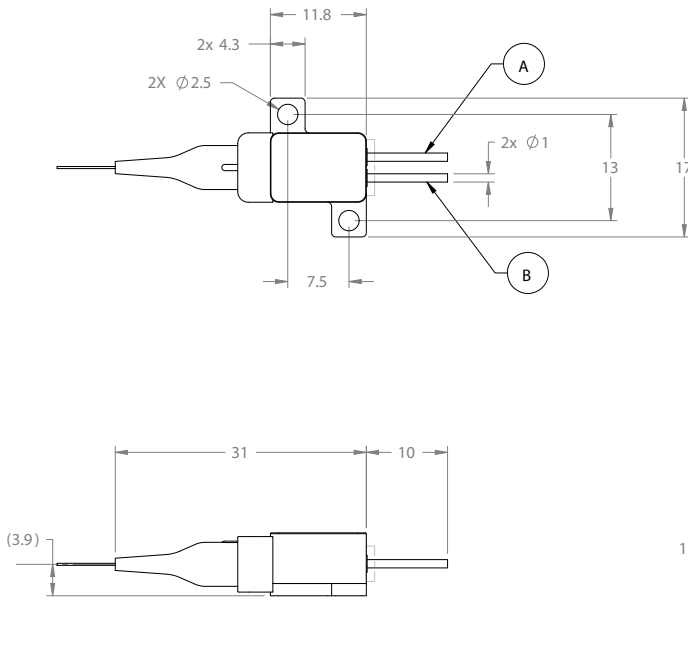

Pinout

Pin	Description
A	Laser cathode (-)
B	Laser anode (+)

3

Specifications for L4-2486-003 and L4-2486-005¹

Parameter	Symbol	Minimum	Typical	Maximum
Laser Characteristics				
CW output power, 0.14 NA	P _o	1.0 W	-	-
Mean wavelength ²	λ_p	815 nm	830 nm	845 nm
Spectral width (90% integrated power)	$\Delta\lambda$	-	2 nm	7 nm
Slope efficiency	η_D	-	0.95 W/A	-
Conversion efficiency	η	-	44%	-
Threshold current	I _{th}	-	280 mA	350 mA
Operating current (BOL)	I _{op}	-	1.4 A	2.0 A
Forward voltage	V _f	-	1.6 V	2.0V
Series resistance	R _s	-	0.07 Ω	-
Recommended case temperature	T _c	20°C	25°C	45°C
Wavelength tuning vs. temperature ³	$\Delta\lambda/\Delta T$	-	0.3 nm/°C	-
Wavelength tuning vs. output power	$\Delta\lambda/\Delta P$	-	1.6 nm/W	-
Fiber Characteristics				
Fiber core diameter	d _c	-	60 μm	-
Fiber numerical aperture	NA	0.20	0.22	0.24
Fiber cladding	d _{cl}	-	125 μm	-
Fiber buffer	d _b	-	250 μm	-
Fiber length	l _f	0.3 m	1 m	2.5 m

1. All performance data is measured at 25°C, beginning of life (BOL).

2. Weighted average "center of mass" spectral point at 25°C at P_o

3. Change in $\Delta\lambda$ mean with case temperature over T_{op}

Specifications for L4-2486-004 and L4-2486-006¹

Parameter	Symbol	Minimum	Typical	Maximum
Laser Characteristics				
CW output power, 0.22 NA	P _o	2.0 W	-	-
CW output power, 0.12 NA	P _o	1.3 W	-	-
Mean wavelength ²	λ_p	815 nm	830 nm	845 nm
Spectral width (90% integrated power)	$\Delta\lambda$	-	2 nm	7 nm
Slope efficiency	η_D	-	1.0 W/A	-
Conversion efficiency	η	-	50%	-
Threshold current	I _{th}	-	280 mA	350 mA
Operating current (BOL)	I _{op}	-	2.3 A	2.7 A
Forward voltage	V _f	-	1.7 V	2.0 V
Series resistance	R _s	-	0.07 Ω	-
Recommended case temperature	T _c	20°C	25°C	45°C
Wavelength tuning vs. temperature ³	$\Delta\lambda/\Delta T$	-	0.3 nm/°C	-
Wavelength tuning vs. output power	$\Delta\lambda/\Delta P$	-	1.6 nm/W	-
Fiber Characteristics				
Fiber core diameter	d _c	-	60 μm	-
Fiber numerical aperture	NA	0.20	0.22	0.24
Fiber cladding	d _{cl}	-	125 μm	-
Fiber buffer	d _b	-	250 μm	-
Fiber length	l _f	0.3 m	1 m	2.5 m

1. All performance data is measured at 25°C, beginning of life (BOL).

2. Weighted average "center of mass" spectral point at 25°C at P_o

3. Change in $\Delta\lambda$ mean with case temperature over T_{op}

4

Absolute Maximum Ratings

Parameter	Symbol	Minimum	Typical	Maximum
Operating current	I _{op}	-	-	3.0 A
Reverse voltage	V _{rvs}	-	-	2 V
Case operating temperature ¹	T _{op}	15°C	-	50°C
Storage temperature ²	T _{stg}	-30°C	-	70°C
Lead soldering temperature, 10 s max	T _{ls}	-	-	300°C
Relative humidity, non-condensing, ambient < 45°C	RH	-	-	85%
Electrostatic discharge (ESD) ³	V _{esd}	-	-	500 V
Fiber bend radius (long term deployment) ⁴		30 mm	-	-
Fiber axial pull force, 15 s		-	-	5 N
Fiber side pull force, 15 s		-	-	2.5 N

1. Non-condensing, maximum

2. Non-condensing, 2000 hours

3. C = 100 pF, R = 1.5 kΩ, human body model, shown to be not damaging to its LI characteristics or its reliability, I-V curves may change in this ESD environment

4. Minimum bend radius of 30 mm is for long term mechanical fiber reliability

Configurations

Product Code	Wavelength Range	Connector ¹	Sheathing	Fiber NA
L4-2486-003	815 – 845 nm	SMA905	Loose-tube PVDF	0.22
L4-2486-004	815 – 845 nm	ST953	Loose-tube PVDF	0.22
L4-2486-005	815 – 845 nm	ST953	Loose-tube PVDF	0.22
L4-2486-006	815 – 845 nm	SMA905	Loose-tube PVDF	0.22

Ordering Information

For more information on this or other products and their availability, please contact your local JDSU account manager or JDSU directly at 1-800-498-JDSU (5378) in North America and +800-5378-JDSU worldwide, or via e-mail at customer.service@jdsu.com.

Sample: L4-2486-003

User Safety
Safety and Operating Considerations

The laser light emitted from this diode laser is invisible and may be harmful to the human eye. Avoid looking directly into the diode laser or into the collimated beam along its optical axis when the device is in operation.

CAUTION: THE USE OF OPTICAL INSTRUMENTS WITH THIS PRODUCT WILL INCREASE EYE HAZARD.

Operating the diode laser outside of its maximum ratings may cause device failure or a safety hazard. Power supplies used with the component must be employed such that the maximum peak optical power cannot be exceeded. CW diode lasers may be damaged by excessive drive current or switching transients. When power supplies are used, the diode laser should be connected with the main power on and the output voltage at zero. The current should be increased slowly while the diode laser output power and the drive current are monitored.

Device degradation accelerates with increased temperature, and therefore careful attention to minimizing the case temperature is advised. For example, life expectancy will decrease by a factor of four if the case is operated at 50 °C rather than 25 °C.





A proper heatsink for the diode laser on a thermal radiator will greatly enhance laser life. Firmly mount the laser on a radiator with a thermal impedance of less than 0.5 °C/W for increased reliability.

ESD PROTECTION—Electrostatic discharge is the primary cause of unexpected diode laser failure. Take extreme precaution to prevent ESD. Use wrist straps, grounded work surfaces, and rigorous antistatic techniques when handling diode lasers.

Labeling
21 CFR 1040.10 Compliance

Because of the small size of these devices, each of the labels shown is attached to the individual shipping container. They are illustrated here to comply with 21 CFR 1040.10 as applicable under the Radiation Control for Health and Safety Act of 1968.

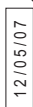
Serial Number Identification Label

Serial:  L4-ABC123	 JDSU JDSU 3 Hongmian Road Futian Free Trade Zone Shenzhen 518038 Made in: China	 12/05/07	 L4-ABC123
Model:  L4-2486-003			

Output Power Danger Label
